

ELEKTROENERĢIJAS RAŽOŠANAS MŪSDIENU TEHNOLOĢIJAS.



Aigars Kalniņš
Saules enerģijas asociācija
18.09.2021



Energize Co2mmunity

SAULES POTENCIĀLS LATVIJĀ

PVGIS

(<http://re.jrc.ec.europa.eu/pvgis/>)

- 1100-1300 kWh/m²
- 825-975 kWh/kWp

SEA

- 886-1066 kWh/kWp

Avots, PVGIS



Global irradiation and solar electricity potential

Optimally-inclined photovoltaic modules

LATVIA / LATVIJA

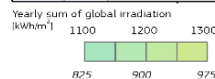

Yearly sum of solar electricity generated by 1kWp system with performance ratio 0.75 [kWh/kW_{pv}]



Joint Research Centre

Authors

Thomas Huld, Irene Hinderi-Huscus
European Commission - Joint Research Centre
Institute for Energy and Transport Renewable Energy Unit
PVGIS <http://re.jrc.ec.europa.eu/pvgis/>

SAULES POTENCIĀLS VĀCIJĀ

PVGIS

(<http://re.jrc.ec.europa.eu/pvgis/>)

- 1100-1450 kWh/m²
- 825-1100 kWh/kWp

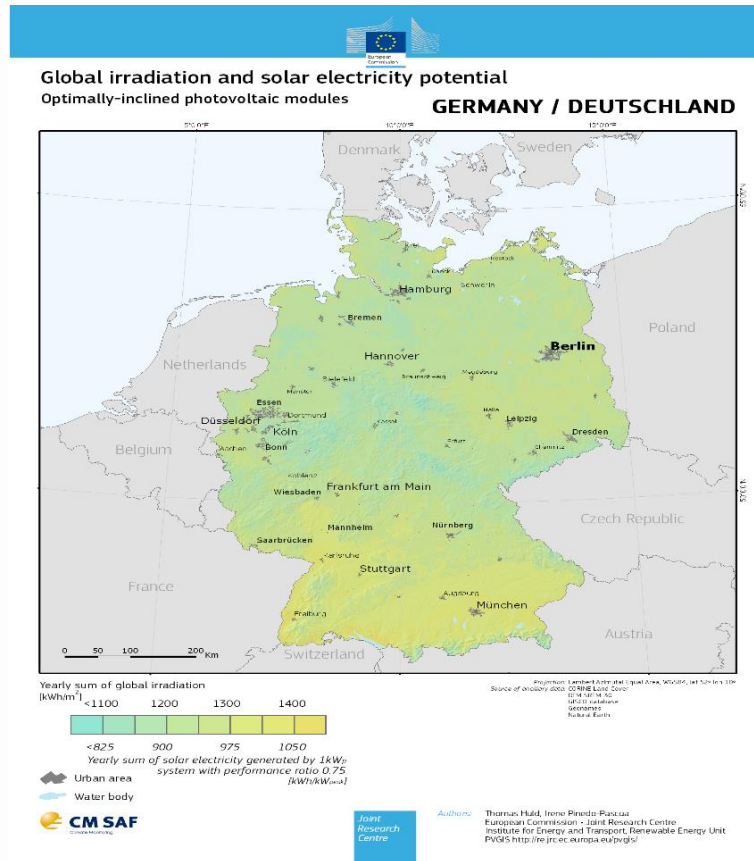

Avots, PVGIS



IZMANTOŠANAS STATISTIKA PASAULĒ, TENDENCES

Tabl. n° 2

Installed and cumulated solar photovoltaic capacity in the European Union at the end of 2019** (MW)*

	2018 cumulated	2019 cumulated	2019 installed
Germany	45 181.0	49 016.0	3 856.0
Italy	20 107.6	20 864.0	759.0
United Kingdom	13 118.3	13 616.0	497.7
France	9 617.0	10 575.9	965.6
Spain	5 239.9	9 232.8	3 992.9
Netherlands	4 522.0	6 924.0	2 402.0
Belgium	3 986.5	4 530.5	544.0
Greece	2 645.4	2 793.8	148.4
Czechia	2 075.1	2 100.0	24.9
Austria	1 437.6	1 660.6	223.0
Romania	1 385.8	1 385.8	0.0
Poland	562.0	1 317.0	755.0
Hungary	726.0	1 277.0	652.0
Denmark	995.0	1 080.0	85.0
Bulgaria	1 032.7	1 065.0	32.3
Portugal	667.4	907.0	220.0
Sweden	428.0	698.0	270.0
Slovakia	472.0	472.0	0.0
Slovenia	221.3	222.0	0.7
Finland	140.0	215.0	75.0
Malta	131.3	150.6	20.0
Luxembourg	130.6	140.6	10.0
Cyprus	118.5	128.7	10.2
Estonia	31.9	107.0	75.1
Lithuania	82.0	82.0	1.0
Croatia	67.7	69.0	1.3
Ireland	24.2	36.0	11.8
Latvia	2.0	3.0	1.0
Total EU 28	115 148.9	130 670.4	15 634.9
Total EU 27	102 030.6	117 054.4	15 137.2

* off-grid included ** Estimation Note: 21 MW decommissioned in Germany, 6.7 MW in France, 1.3 MW in the Czech Republic, 0.8 MW in Italy and 0.5 MW in Malta. Source: EurObserv'ER 2020

IZMANTOŠANAS STATISTIKA PASAULĒ, TENDENCES

Uzstādītās
elektrostacijas
ārpus EU

Tabl. n° 1

Capacity installed in 2019 by the main non-EU photovoltaic markets*

Countries	Newly added capacity in 2018 (GW)
China	30.1
United States	13.3
India	7.7
Japan	7.0
Vietnam	5.6
Australia	4.6
Ukraine	3.9
Mexico	1.9
United Arab Emirates	1.3
Turkey	0.9

** Estimation Sources : NEA (China), SEIA (United States), RTS Group (Japan), IRENA (others).*

IZMANTOŠANAS STATISTIKA PASAULĒ, TENDENCES

Tabl. n° 4

Top 10 Solar Panel Manufacturers In 2019 (modules shipment, in GW)

Company		2018 shipments	2019 shipments	Growth 18/19
JinkoSolar	China	11,4	14,3	26%
JA Solar	China	8,8	10,3	17%
Trina Solar	China	8,1	9,7	20%
Longi Solar	China	7,2	9,0	25%
Canadian Solar	Canada-China	6,6	8,6	30%
Hanwha Q Cells	South Korea	5,5	7,3	33%
Risen Energy	China	4,8	7,0	46%
First Solar	United-States	2,7	5,4	100%
GCL	China	4,1	4,8	17%
Shunfeng Photovoltaic	China	3,3	4,0	21%

Source: 2019 Annual reports (First Solar, Canadian Solar, JinkoSolar), others Globaldata 2020 (preliminary results)

IZMANTOŠANAS STATISTIKA PASAULĒ, TENDENCES

Cenu dinamika
kristāliskā silīcija
paneļiem 2020-2021

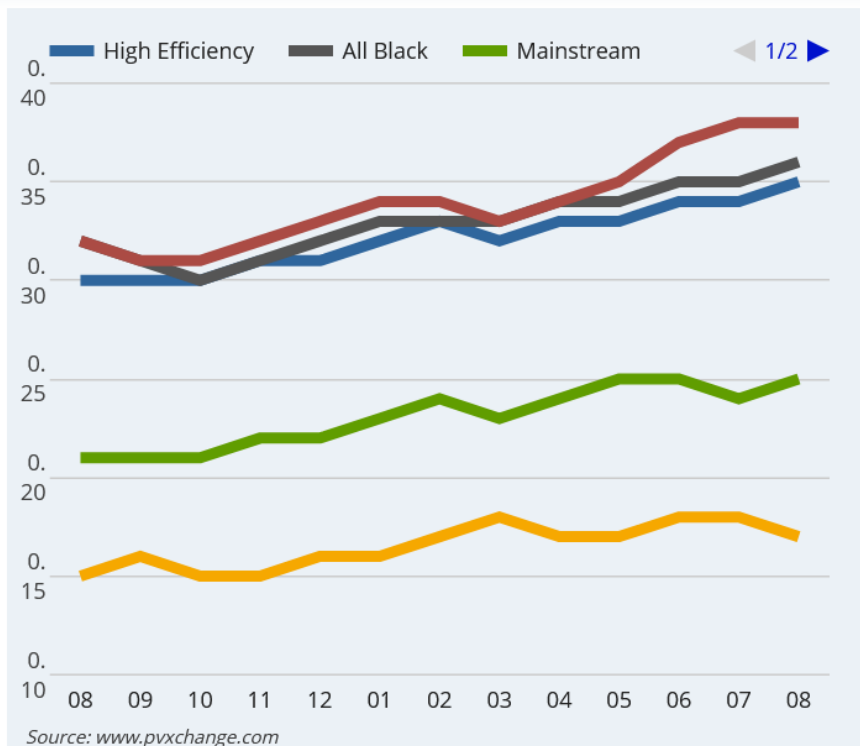

Overview by technology of different price points in **August 2021**, including the changes over the previous month:

IZMANTOŠANAS STATISTIKA LATVIJĀ 2010-2018

LATVIJĀ UZSTĀDĪTĀ FOTOELEKTRISKĀ (PV) SUMMĀRĀ JAUDA

5,0 MWp

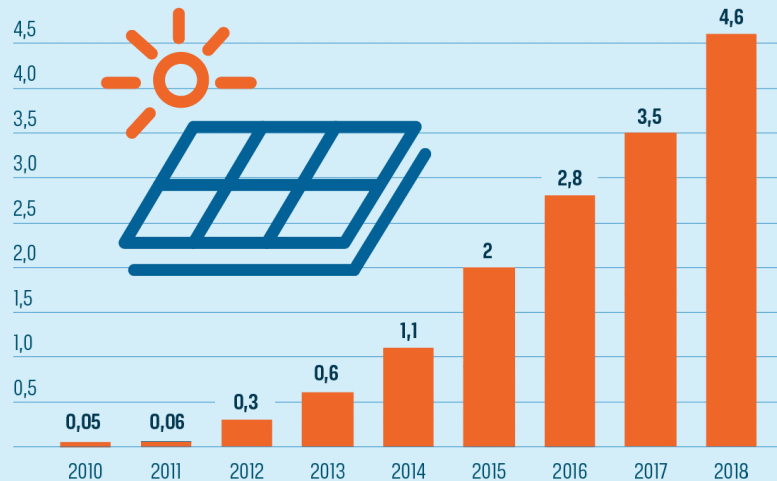

Dati: Latvenergo, Saules enerģijas asociācija

LATVIJĀ UZSTĀDĪTĀ FOTOELEKTRISKĀ (PV) SUMMĀRĀ JAUDA

5,0 MWp

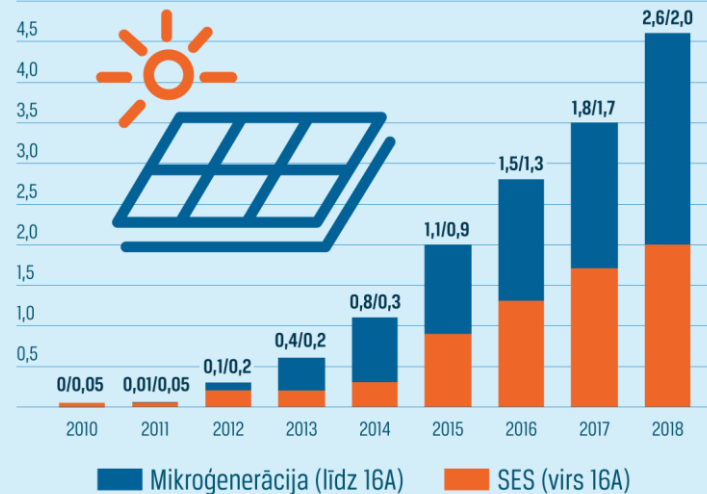

Dati: Latvenergo, Saules enerģijas asociācija

TENDENCES LATVIJĀ 2021

Elektroenerģijas ražotāji (neskaitot mikroģeneratorus) uz 31.03.2021

Elektroenerģijas ražošanas veids	Skaitis	Atļautā jauda, kW
Biogāzes koģenerācijas stacija	57	62 713
Biomasas koģenerācijas stacija	47	71347
Dabas gāzes koģenerācijas stacija	74	74 148
Hidroelektrostacija	141	28 323
Saules elektrostacija	71	3 907
Vēja elektrostacija	70	51 045
Kopā:	460	291 482

Avots, ST

TENDENCES LATVIJĀ 2021

Tikai mikroģeneratori* uz 31.03.2021		
Elektroenerģijas ražošanas veids	Skaitis	Atļautā jauda, kW
Dabas gāzes koģenerācijas stacija (degvielas šūnas)	2	3
Saules elektrostacija	1 212	7549
Vēja elektrostacija	27	168
Vēja un saules elektrostacija	2	19
Kopā:	1 243	7 738

Avots, ST

ĢENERĀCIJAS SISTĒMU VEIDI

- Tīklievades (on-grid), darbojas paralēli operatora tīklam.

Elektroapgādes tīklam pieslēgta sistēma dienas gaišajā laikā ražo elektroenerģiju pašpatēriņam. To, kas paliek pāri, nodod elektrotīklā.



Avots, SunThor

ĢENERĀCIJAS SISTĒMU VEIDI

- Tīklievades ar uzkrāšanu

Elektroapgādes tīklam pieslēgta sistēma dienas gaišajā laikā ražo elektroenerģiju pašpatēriņam. To, kas paliek pāri, uzkrāj akumulatoros



Avots, SunThor

ĢENERĀCIJAS SISTĒMU VEIDI

- Autonoma (of-grid), darbojas patstāvīgi bez ārēja tīkla.

Autonoma sistēma (bez elektrotīkla pieslēguma) saražoto elektroenerģiju uzkrāj akumulatoros.



Avots, SunThor

ĢENERĀCIJAS SISTĒMU VEIDI

- Hibrīda (hybrid), kombinēta darbojas paralēli ar dažādiem ģenerācijas avotiem.



Avots, SunThor

ĢENERĀCIJAS SISTĒMU VEIDI

- Rezerves barošanas (back up)



Avots, SunThor

DARBA REŽĪMI (PAŠPATĒRIŅŠ)

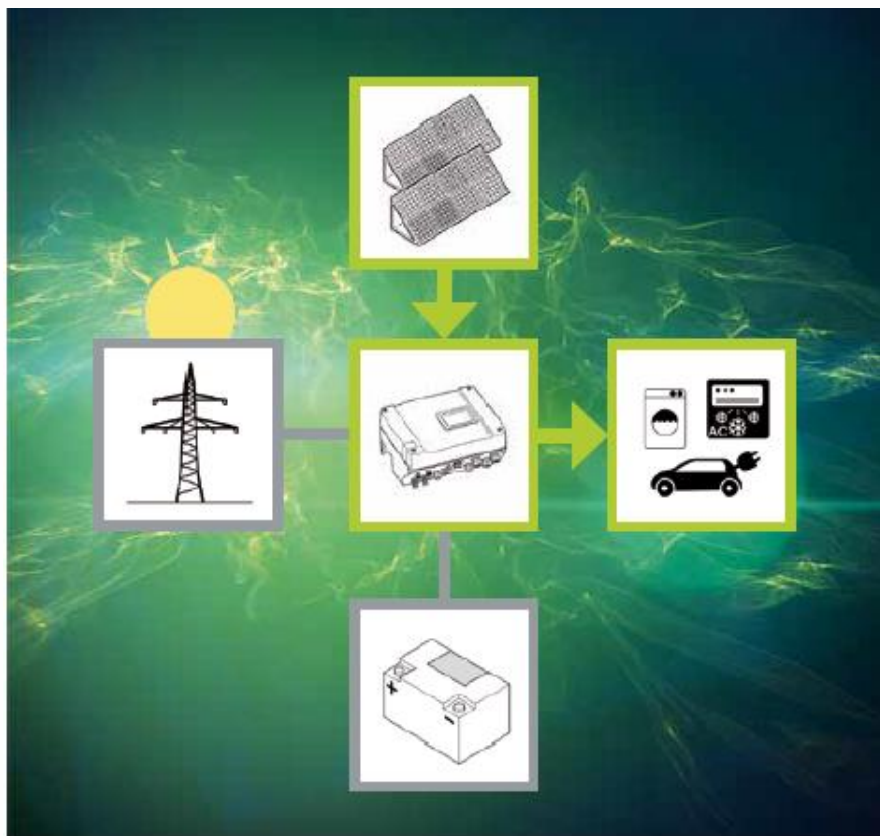

DARBA REŽĪMI (UZLĀDE)

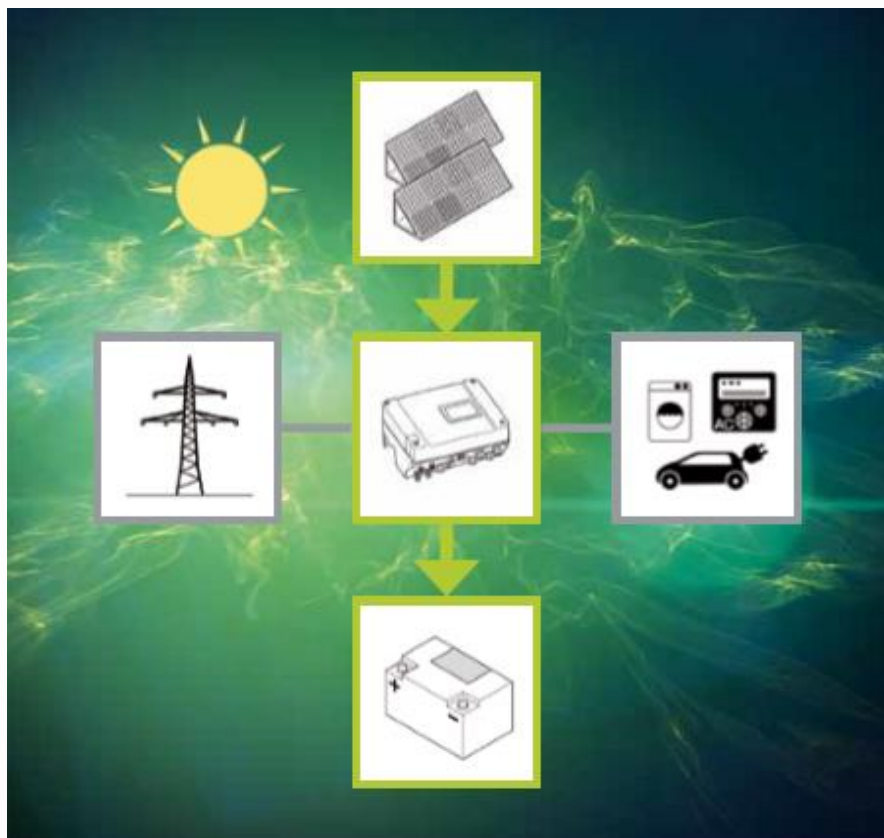

DARBA REŽĪMI (MAKSIMUMS)

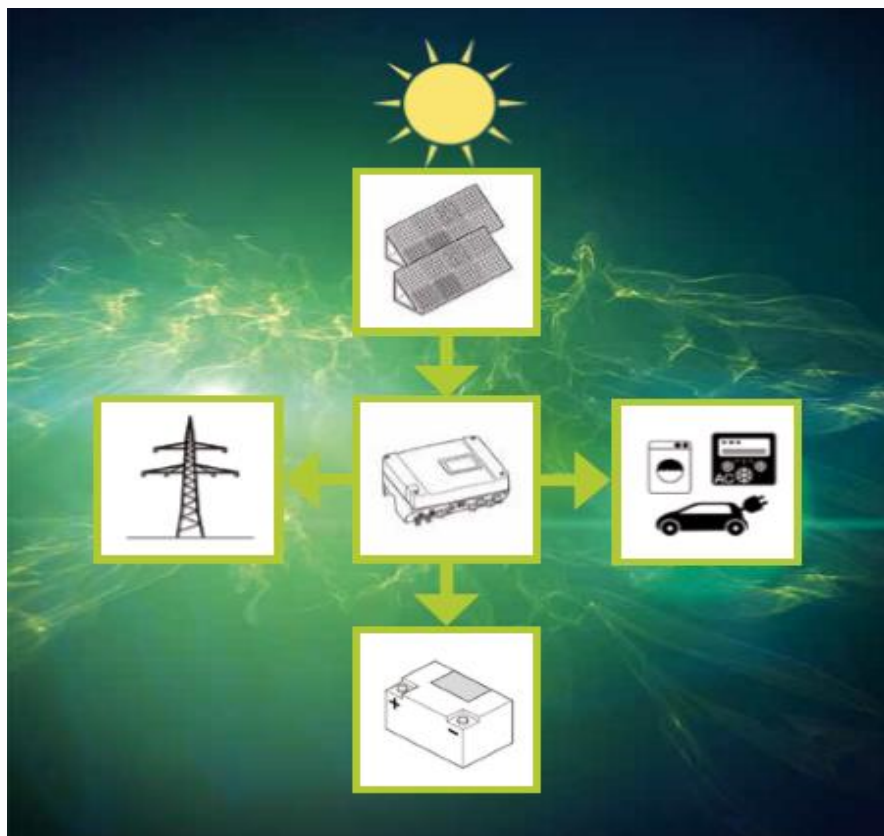

DARBA REŽĪMI (ĢENERĀCIJA + AKUMULATORI)

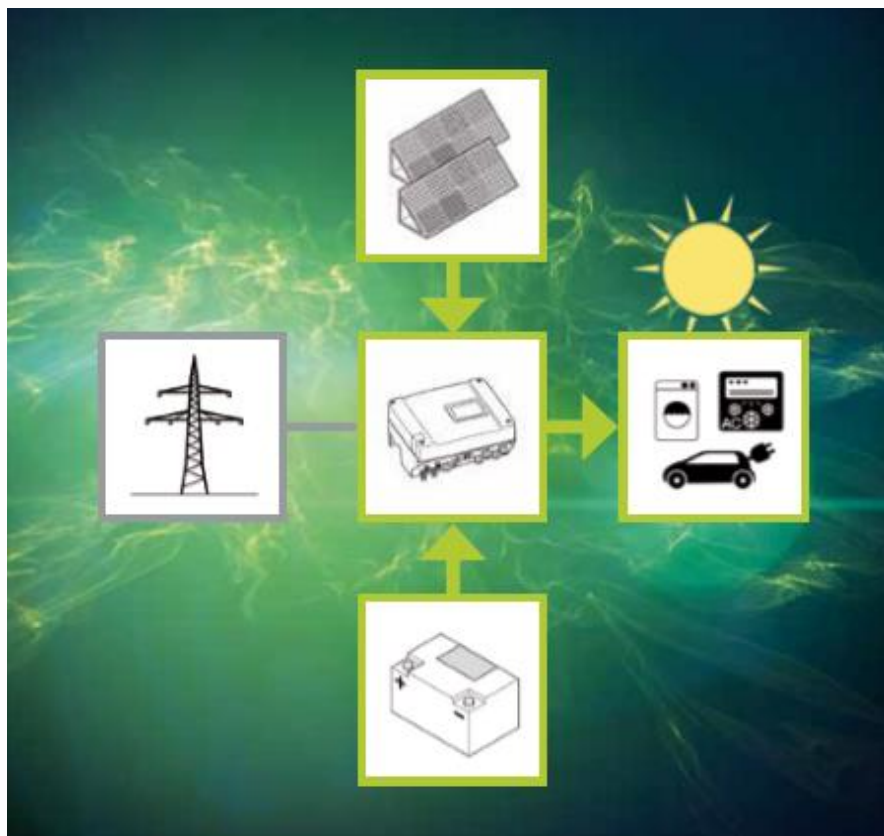

DARBA REŽĪMI (TĪKLS)

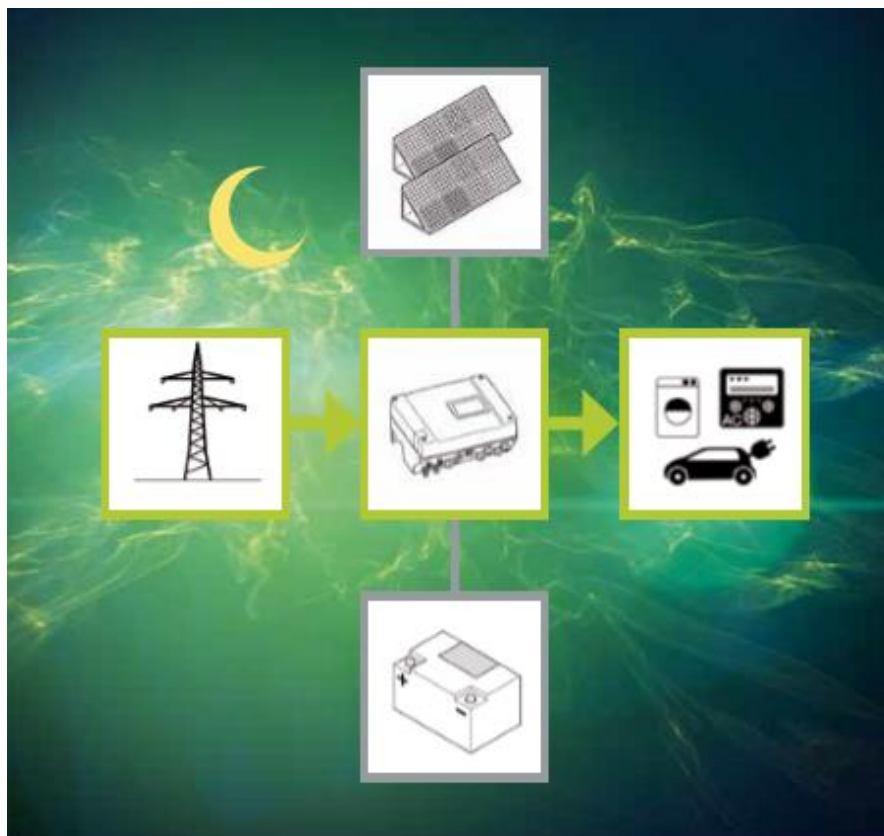

DARBA REŽĪMI (REZERVE)

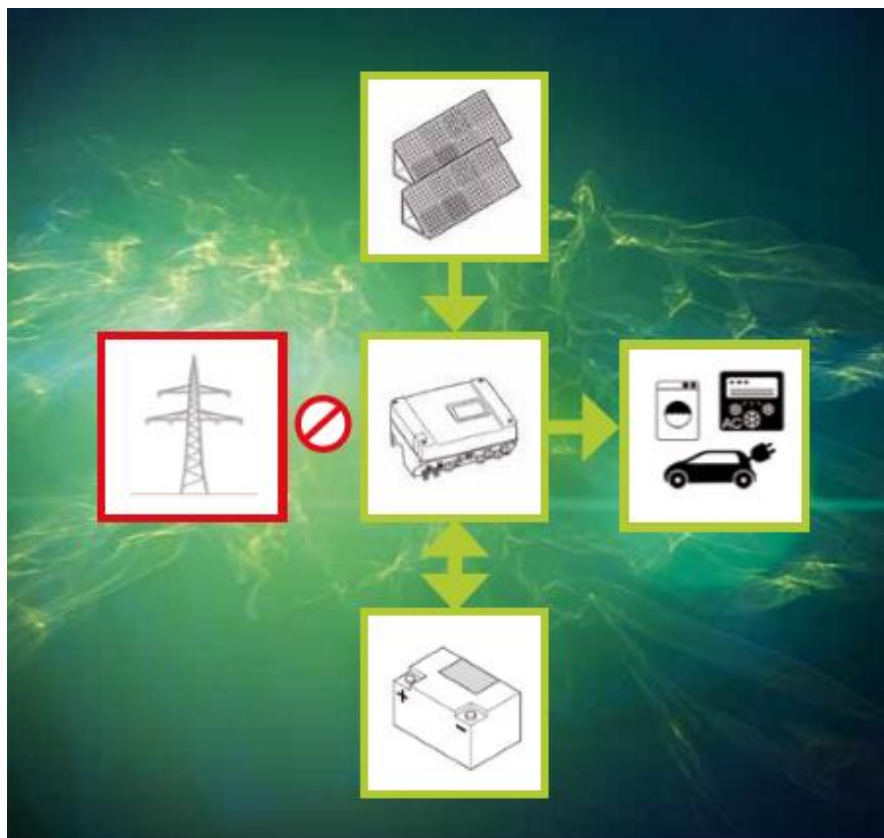

SISTĒMAS APRĒĶINS

Annual averages

Total photovoltaic power output and Global tilted irradiation

1.001

MWh per year

1227.5

kWh/m² per year

Monthly averages

Total photovoltaic power output

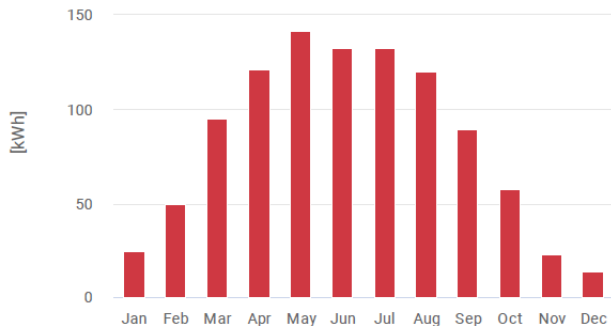

Average hourly profiles

Total photovoltaic power output [Wh]



UTC+02

SISTĒMAS APRĒKINS

Average hourly profiles

Total photovoltaic power output [Wh]

	Jan	Feb	Mar	Apr	May	Jun	Jul	Aug	Sep	Oct	Nov	Dec
0 - 1												
1 - 2												
2 - 3												
3 - 4												
4 - 5						5	1					
5 - 6				0	19	27	20	3				
6 - 7				29	69	75	61	38	5			
7 - 8			34	131	186	185	161	134	85	11		
8 - 9		31	166	267	327	312	286	263	205	114		
9 - 10	19	154	289	399	451	421	405	376	318	216	81	2
10 - 11	129	235	382	488	528	495	484	453	390	273	129	77
11 - 12	159	271	424	527	565	525	525	486	403	289	141	114
12 - 13	172	284	437	529	558	512	518	491	407	295	151	119
13 - 14	163	286	432	510	528	496	497	470	385	283	138	102
14 - 15	124	264	387	449	464	446	436	413	333	226	96	25
15 - 16	26	181	285	352	377	362	353	331	244	142	17	0
16 - 17		63	175	235	274	276	269	231	146	24		
17 - 18			63	116	155	168	168	128	51			
18 - 19				25	53	68	68	40	2			
19 - 20				1	16	29	26	5				
20 - 21						5	3					
21 - 22												
22 - 23												
23 - 24												
Sum	793	1,768	3,074	4,057	4,570	4,406	4,281	3,862	2,975	1,874	754	440

SISTĒMAS APRĒĶINS

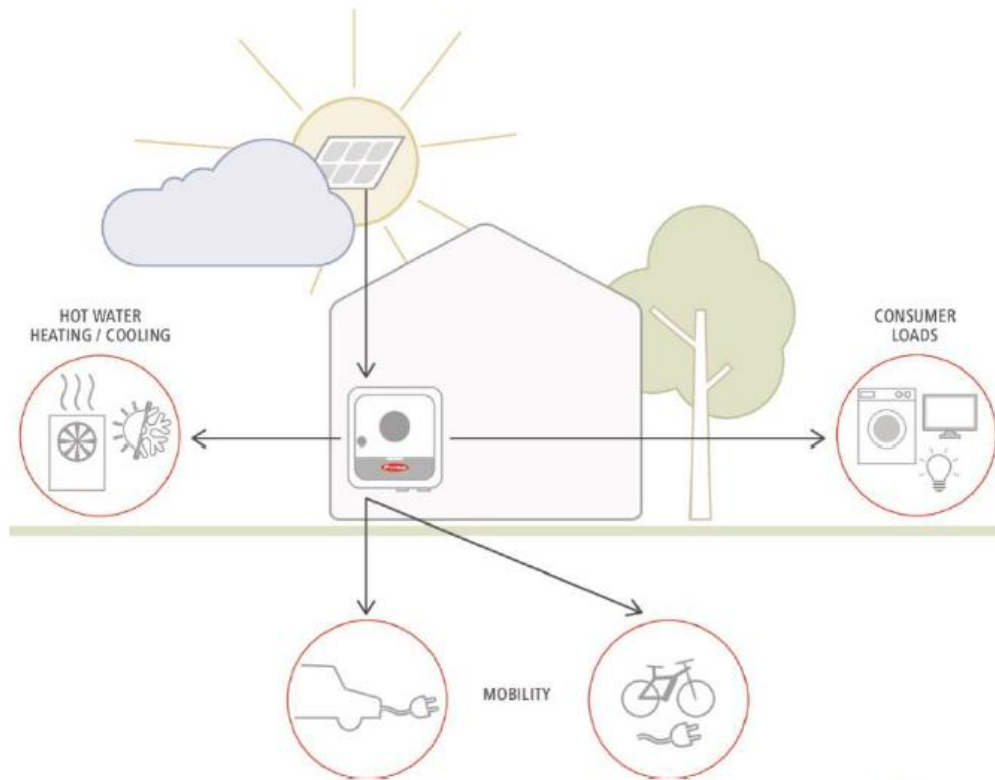

HOT WATER PREPERATION WITH FRONIUS OHMPILOT

Dynamic control of the surplus energy

/ Required components:

/ Fronius Inv. with Datamanager 2.0

/ or Fronius GEN24

/ Fronius Smart Meter

/ Fronius Ohmpilot (Temp. sensor optional)

/ Boiler with electric heating rod

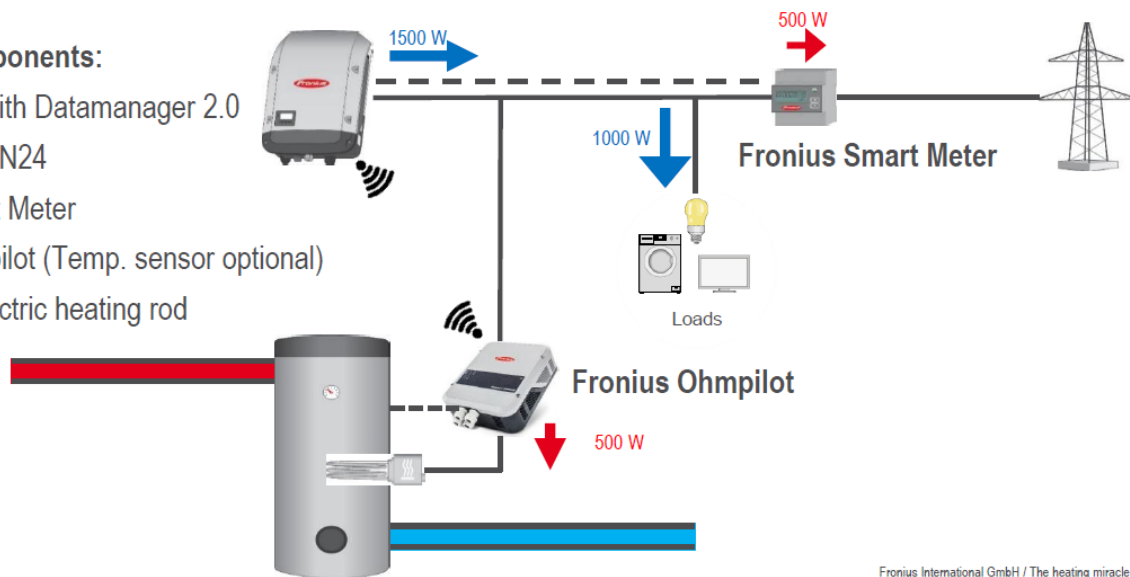

GENERATING HOT WATER WITH THE SUN

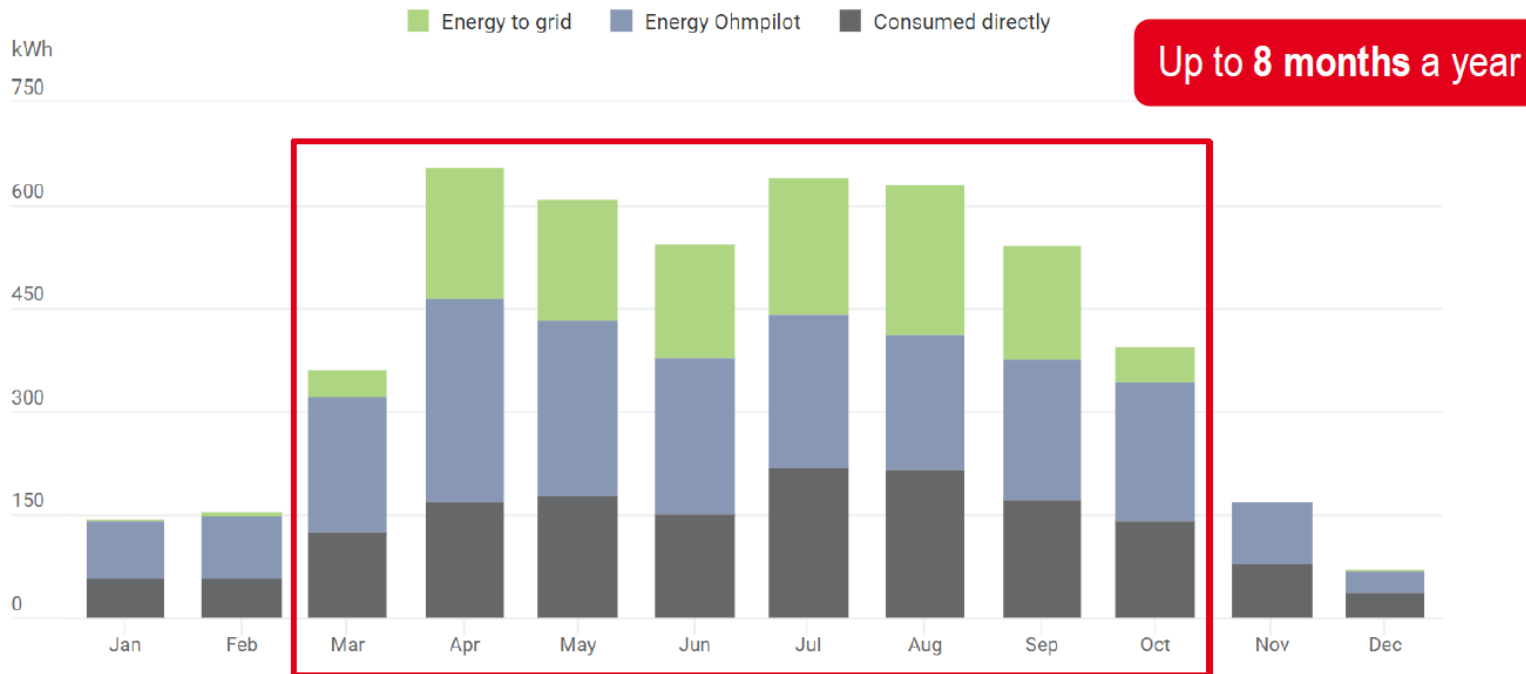

7

Fronius International GmbH / The heating miracle Fronius Ohmpilot

SISTĒMAS APRĒĶINS

Elektroenerģijas gada patēriņš dalīts ar 1000 ($3600 / 1000 = 3.6\text{kW}$)

+ nodrošināt ūdens sildīšanu vasaras mēnešos x1,5 (5,4kW)

+ nodrošināt elektro auto uzlādi x 1,4 (7,56kW)

IZMAKSU APRĒĶINS

1 kw gadā saražo 1000 kWh

Tarifs 0,23 EUR/KWh

$1000 \times 0,23 = 230$ EUR (jāatskaita ampērmaksa)

$3,6 \times 900 = 3240$ EUR

$3240 / 230 = 14$ gadi

DARBA REŽĪMI (DIENNAKTS CIKLS BA SISTĒMAI)

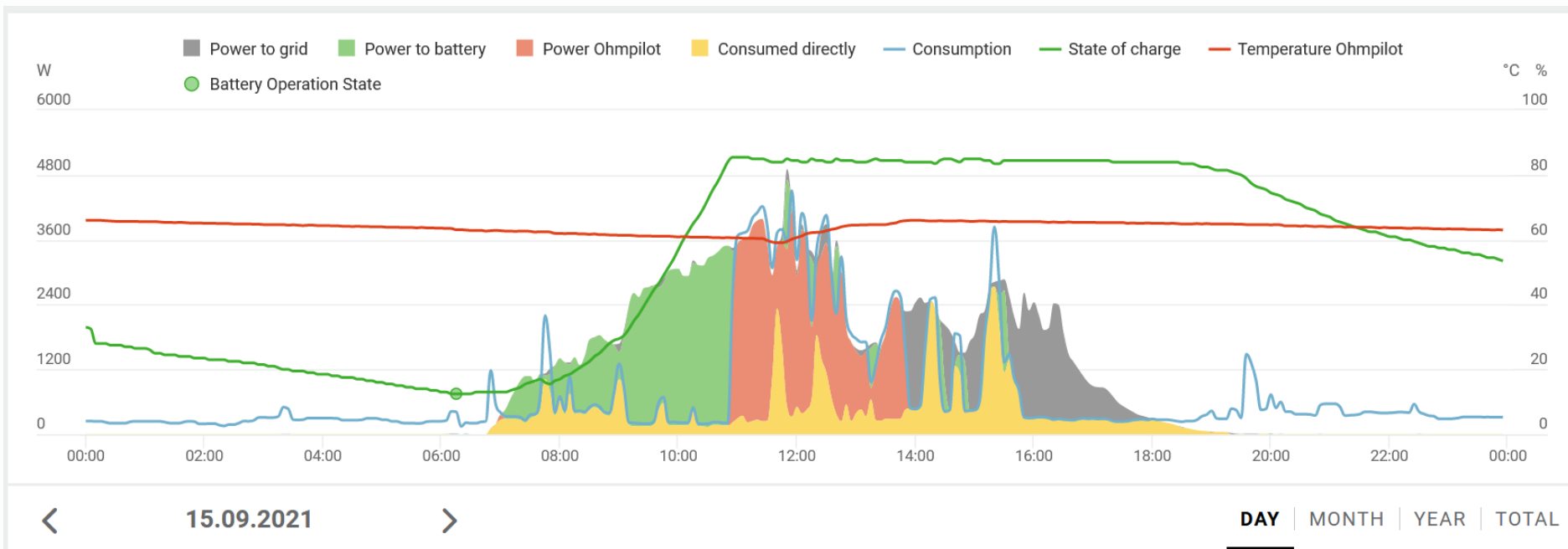

DATU MONITORINGS

Current Power 1.84 kW	Energy today 7.47 kWh	Energy this month 31.65 kWh	Lifetime energy 11.28 MWh
---------------------------------	---------------------------------	---------------------------------------	-------------------------------------



Power and Energy

Day Week Month **Billing Cycle** Year

01/09/2019 - 29/09/2019

System Production: **499.58 kWh**

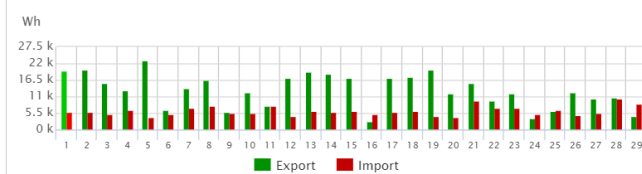
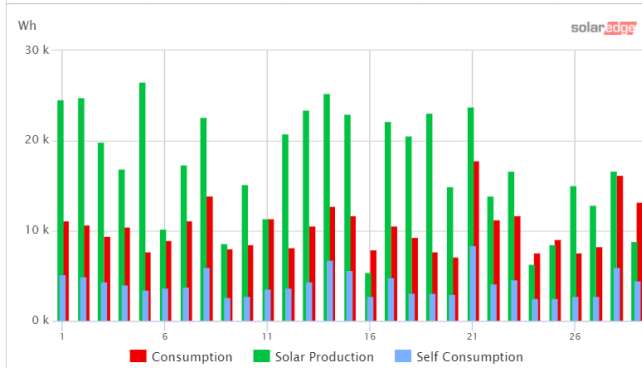

Name: 0 6KWH LATVIETIS ANDRIS

Country: United Kingdom

Installed: 29/09/2017

Last Updated: 05/02/2020 13:52

Peak Power: 6 kWp

Mostly Cloudy
6 °C
Feels like 6 °C

Wind N, 0 km/h
Humidity 74 %
Sunrise at 07:34
Sunset at 16:51

Wednesday Thursday Friday

8 - 0 °C Mostly Cloudy

8 - 2 °C Partly Cloudy

8 - 5 °C Mostly Sunny

Environmental Benefits

CO2 Emission Saved
2,882.59 kg

Equivalent Trees Planted
14.77

Comparative Energy

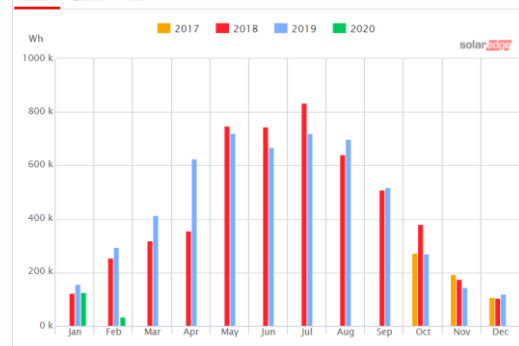

359.25 Wh	493.5 Wh	509.25 Wh	508.75 Wh	504.75 Wh	520.5 Wh	515.5 Wh	499.5 Wh
1.0.13	1.0.7	1.0.20	1.0.11	1.0.19	1.0.14	1.0.8	1.0.9
135.75 Wh	298.75 Wh	412.5 Wh	484 Wh	509.75 Wh	512.75 Wh	498.25 Wh	509.25 Wh
1.0.15	1.0.12	1.0.6	1.0.10	1.0.16	1.0.21	1.0.17	1.0.18

9.55 kWh

468.5 Wh	467 Wh
1.0.2	1.0.1
481.25 Wh	477.25 Wh
1.0.5	1.0.4
460.25 Wh	1.0.3



DATU MONITORINGS



PIESLĒGUMA SHĒMA, PIEDERĪBAS ROBEŽA

5. Pielikums AS „Sadales tīkls” kārtībai SAD_K101

Mikroģeneratora tipveida pieslēguma shēma paralēlam darbam ar AS „Sadales tīkls” zemsprieguma elektrotīklu

1. Ģenerators (turbīna, saules paneļi u.c.)
2. Pārveidotājs / invertors, tīkla aizsardzības iekārtas
3. Automātslēdzis ar nominālo strāvu $\leq 16A$ (kalpo jaudas ierobežošanai un MĢ atslēgšanai)
4. Ievadaizsardzības aprāts
5. Divvirzienu aktīvās un reaktīvās elektroenerģijas skaitītājs
6. AEUS gala iekārta / modems
7. Elektroietaišu piederības un apkalpes robeža (robežas atrašanās vieta var atšķirties, to nosaka individuāli katrā objektā, atbilstoši ETLN)

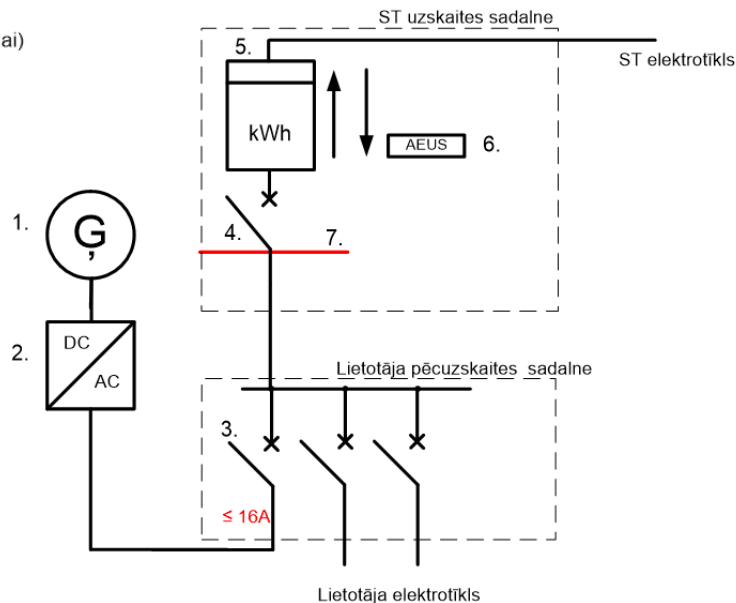

Avots, ST

FOTOELEKTRISKO PANEĻU TIPI, VEIDI

Montāžas veidi:



IZMANTOŠANAS VEIDI, ALTERNATĪVAS

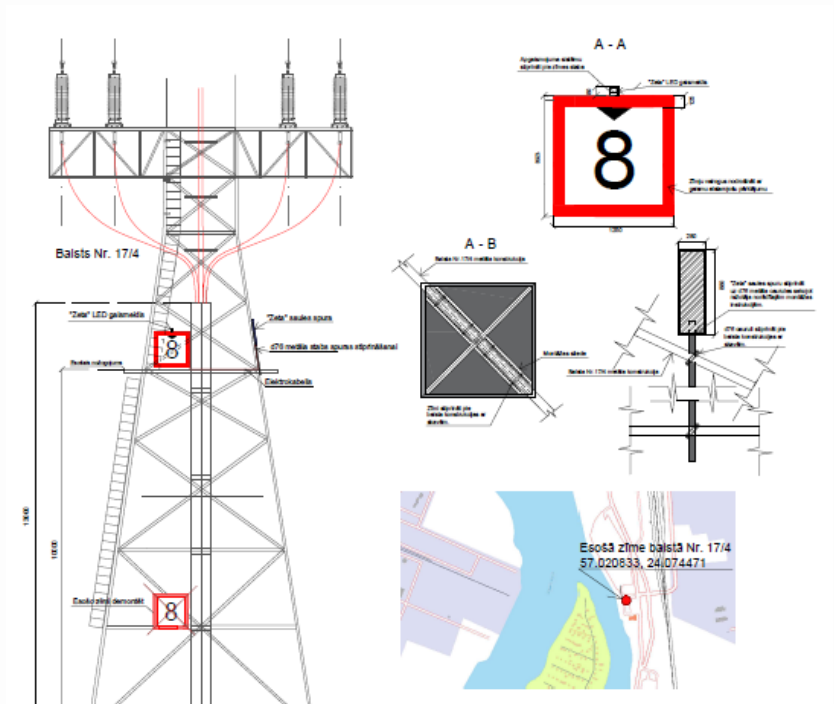

INFO

Informācija par ģeneratoru pieslēgumu:

<https://www.sadalestikls.lv/klientiem/pieslegumi>

PALDIES

a.kalnins@saulesbiedriba.lv

29231243