



Linking Estonia and Latvia
Part-financed by the European Regional Development Fund



European Union



RIGA PLANNING REGION

Liesma Grīnberga

Riga Planning Region / Project Coordinator

Riga, 17th June, 2010

Riga Planning Region in Latvia

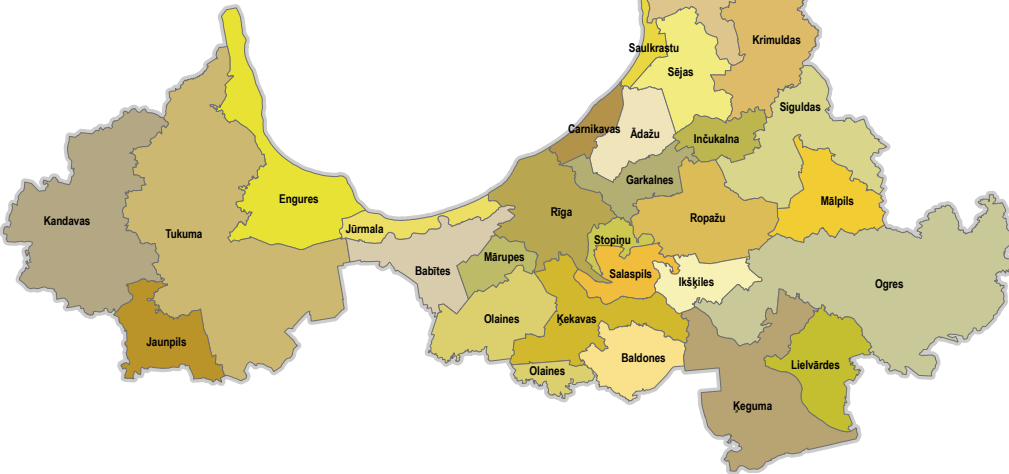

NUTS III region

Territory: 10 441,5 km²

Inhabitants: 48% of all Latvia's inhabitants; the largest region in the Baltic States with ~ 1, 1 million inhabitants

Density of population:

RPR territory includes **20** towns, live 85 % of all inhabitants of region;

30 local municipalities (after Administrative Territorial Reform);

2 republican cities;

3 regional centers;

25 counties

GDP: 7235 LVL per capita

Administrative body of Riga region – Riga Planning Region



- **State institution** - established on 12th October, 2006
- **Legal form** – derivative public person
- **Functions** – identified in the Law of Regional Development, chart 16'
- **Financial sources** – state budget, attracted resources in the framework of projects



Linking Estonia and Latvia
Part-financed by the European Regional Development Fund



The main functions of Riga Planning Region

RPR provides development planning, coordination, cooperation among state institutions and local governments in the framework of his competence, including:

- Determine main long-terming aims and priorities of regional development
- Provides coordination of RPR development
- Management and monitoring of elaboration and implementation of RPR development Program;
- Evaluates accordance of National Development documents to the regional documents
- Coordinates and promotes support activities for regional development, etc.



Regional planning tools

	<p>Riga Region Development Strategy 2000.-2025. (adopted in 2008)</p>	
	<p>Riga planning region spatial strategy 2005-2025 /adopted in 2007/</p>	<p>Riga planning region development plan</p>
	<p>Riga region development program 2005-2011 /adopted in 2005/</p>	
	<p>Riga planning region innovative development program 2005-2011 /adopted in 2005/</p>	<p>Sector policy document</p>



Innovation environment in region

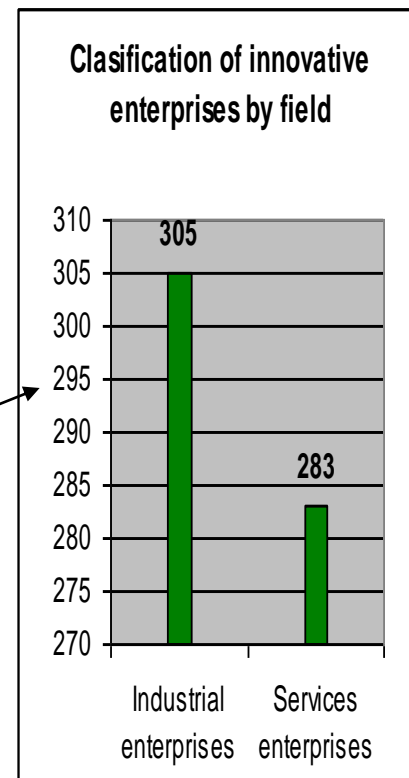
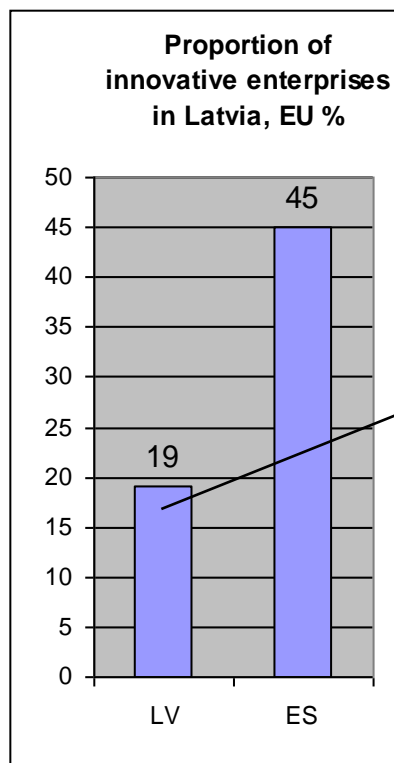
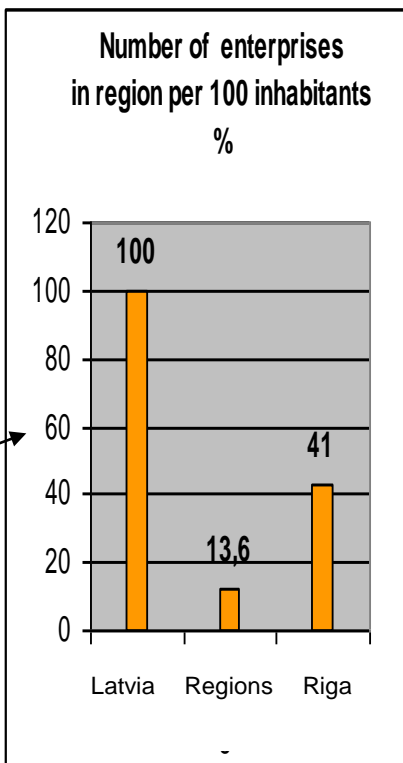
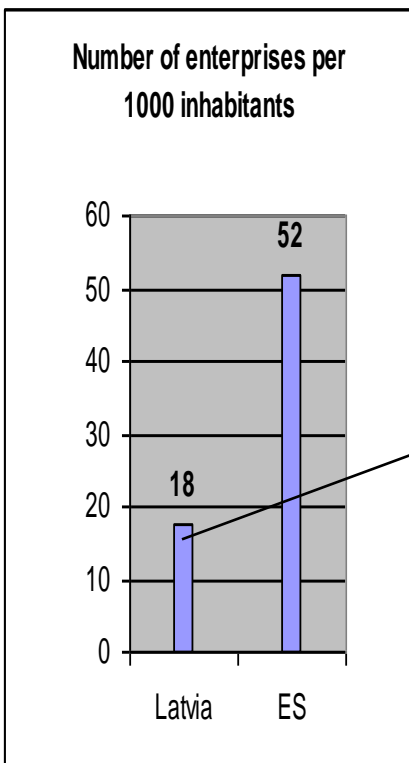

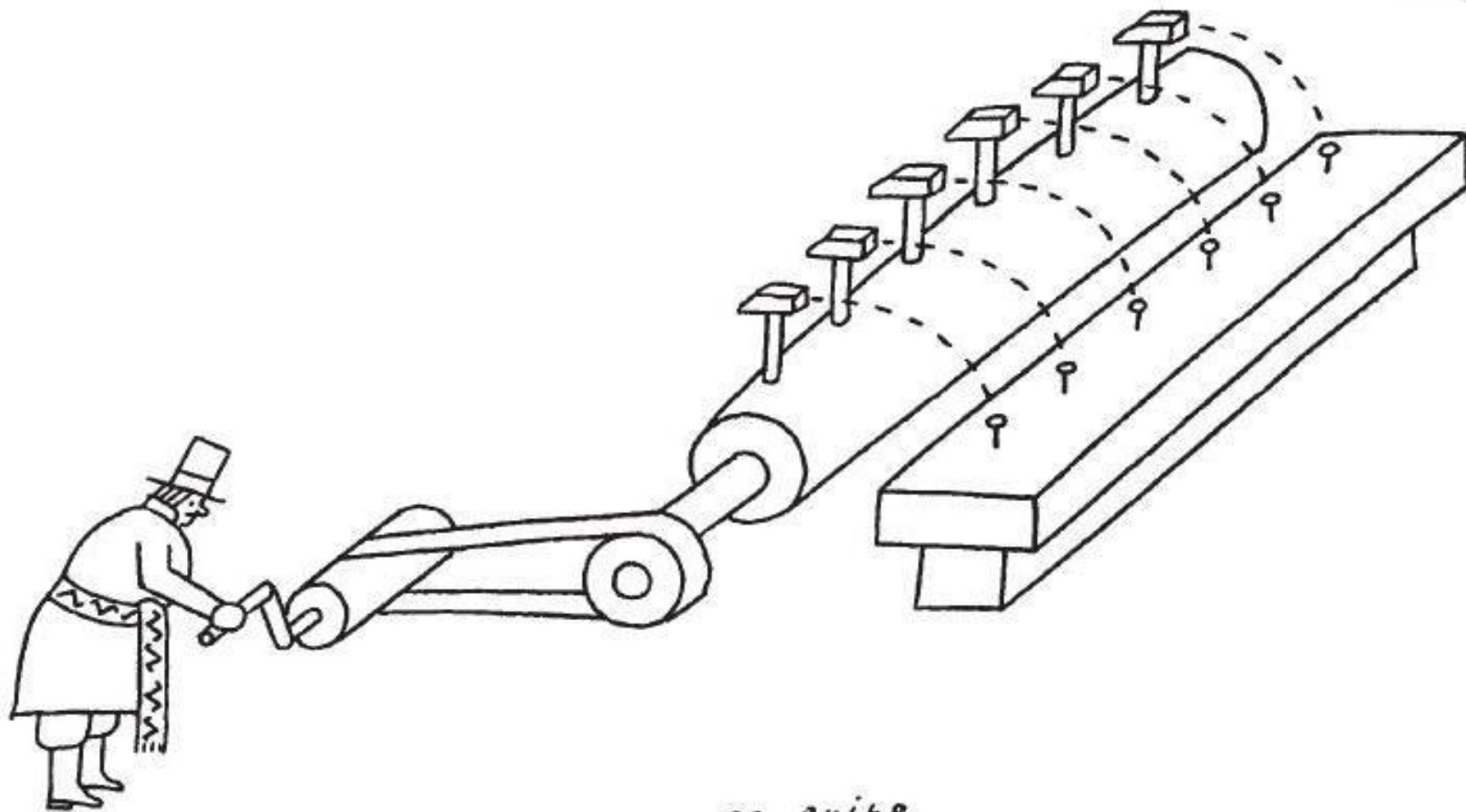

LATVIANS LIKE TO BUILD
INTERESTING THINGS

Reference: Māris Bišofs / "My Latvia"



Linking Estonia and Latvia
Part-financed by the European Regional Development Fund

Mission of RPR

in accordance with

- regional development documents
- SIB Net project

Provides an environment and conditions appropriate for successful business development.



Project area

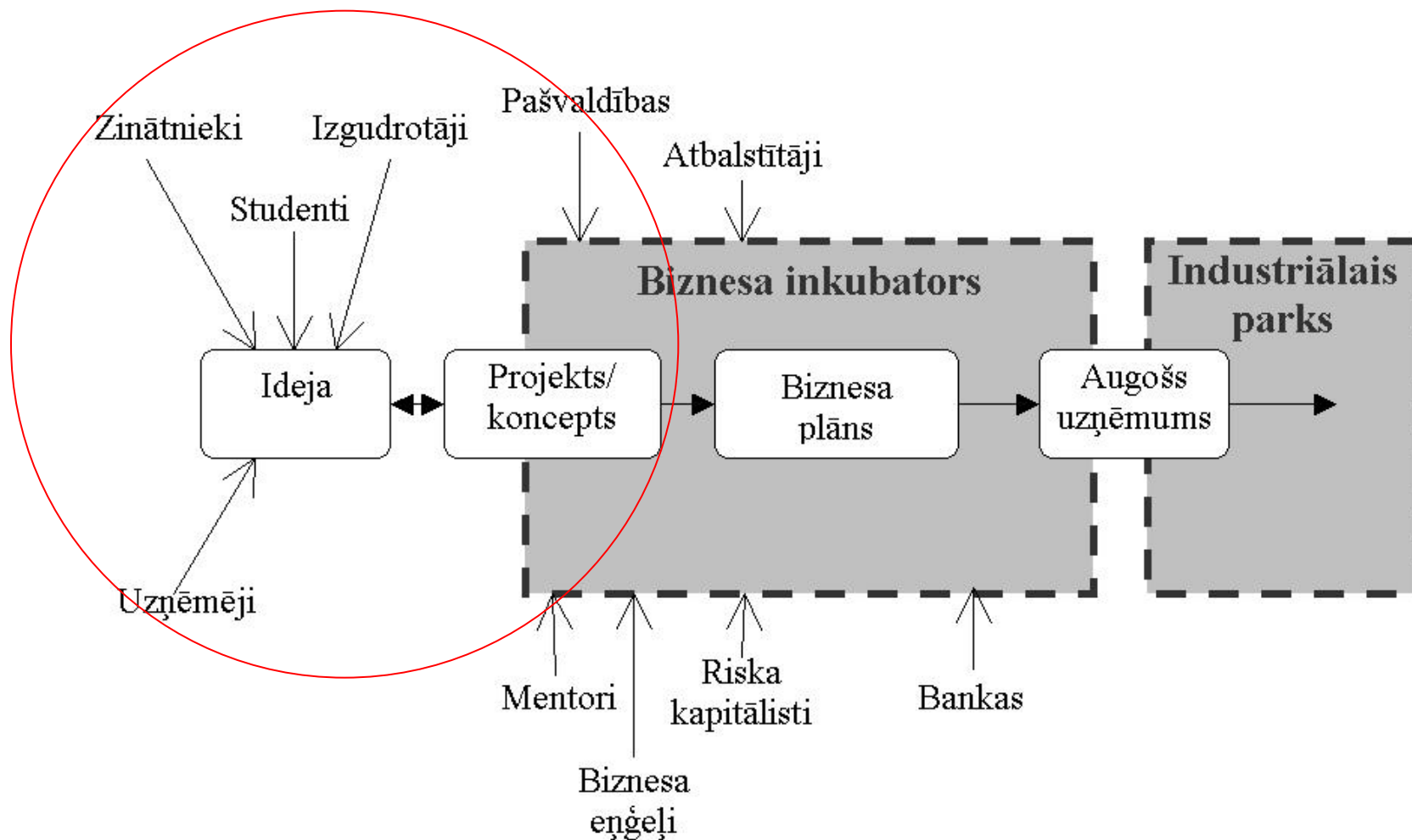

Responsibilities

- coordination of the project implementation process
- Active participation in the project activities
- To provide realization of such activities as
 - Research of early stage business needs,
 - research of existing pre-start and early stage finance support etc.

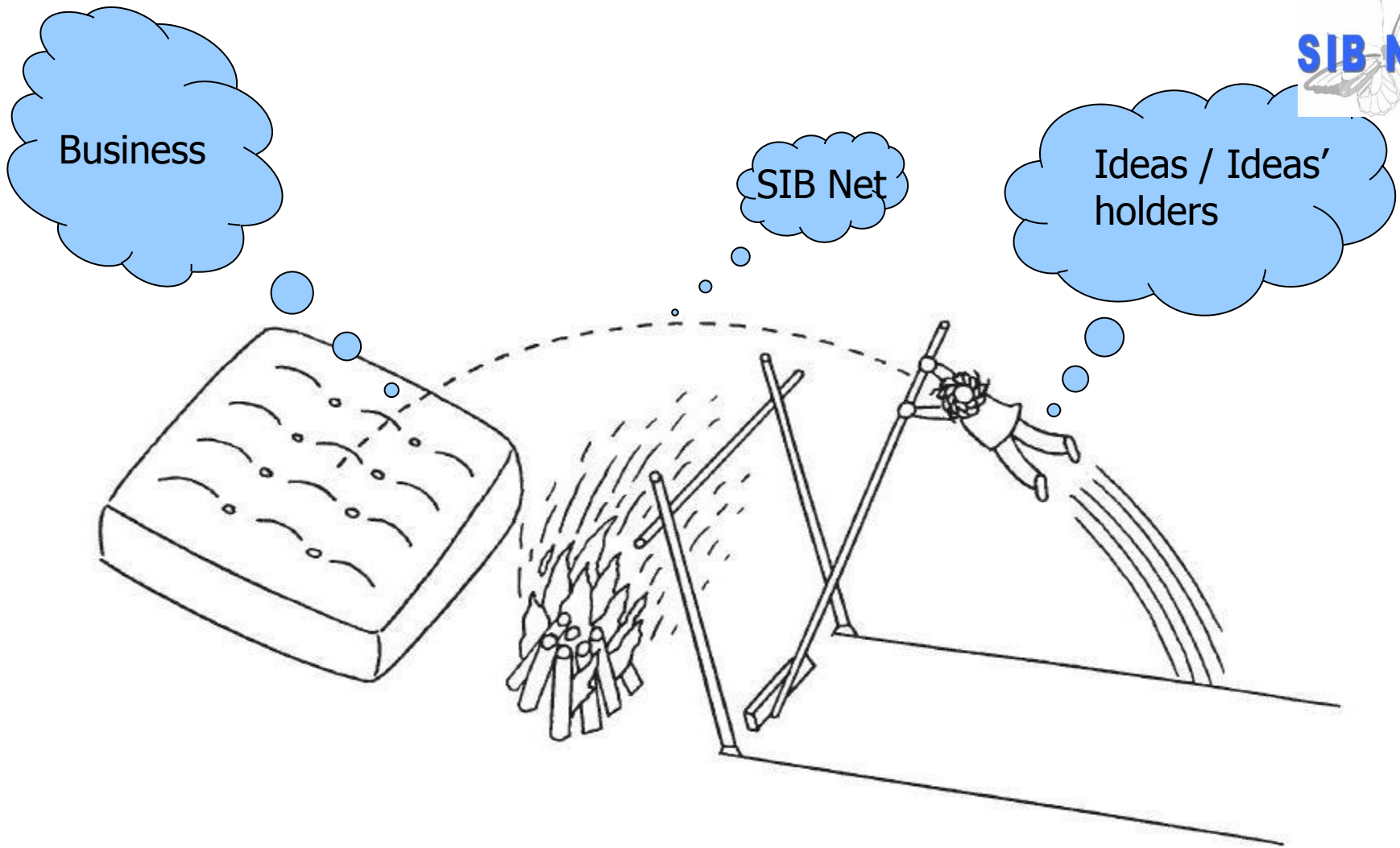

LATVIANS
LIKE TO JUMP OVER
BONFIRES DURING
THE SUMMER SOLSTICE

Reference: Māris Bišofs / "My Latvia"

Thank you for your attention!

RIGA PLANNING REGION

Zigfrida Annas Meierovica blvd. 18,
Riga, LV – 1050

Phone: + 371 6 7226430

Fax: + 371 6 7226431

E-mail: rpr@rpr.gov.lv

Web: www.rpr.gov.lv

